

Hollow Metal Door Frame (by Security Metal Products)

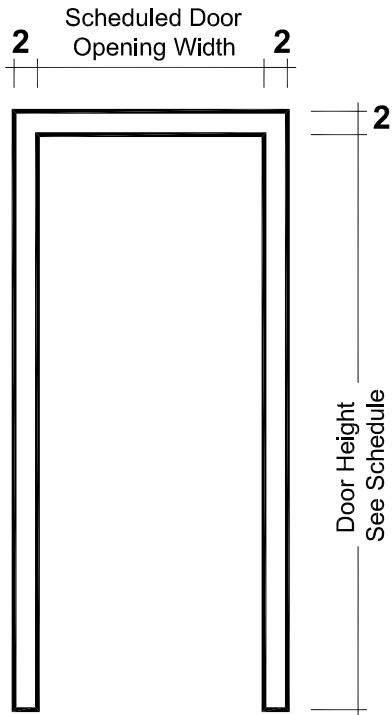

TYPICAL ELEVATION

TYPICAL FRAME PROFILES



Double Rabbet



Single Rabbet



Cased Opening

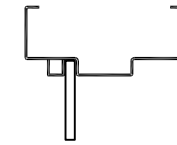

Standard Glazing



Double Egress

TYPICAL FRAME ANCHORS

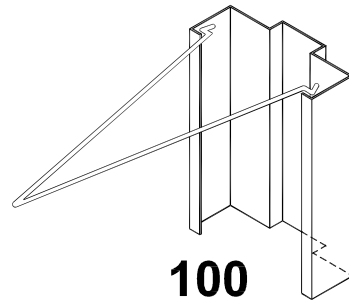

100

Masonry Anchor

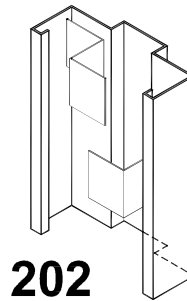

202

Steel Stud Anchor

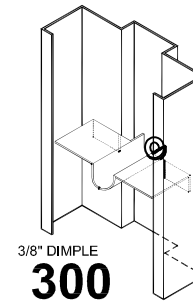

300

Existing Anchor

1/8" Hole in Straps
For # 8 Screw or
8d Nail @ 24" O.C.
max at Straps

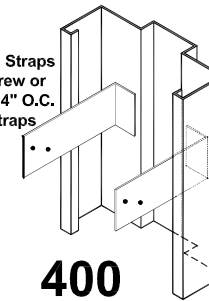

400

Wood Stud Anchor

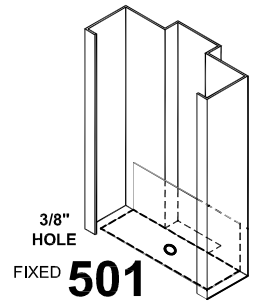

3/8" HOLE
FIXED **501**

Floor Anchor

SPECIFICATIONS:

- 1.) Pre-assembled Welded Frames
- 2.) Galvanized Steel
- 3.) Door Frames Rated up to 3 Hours
- 4.) Window Frames Rated up to 1 Hour
- 5.) 12 Gauge Reinforcement for Surface Applied Hardware
- 6.) 16, 14 & 12 Gauge Available
- 7.) Baked on Prime Paint
- 8.) 3/16" Hinge Reinforcement
- 9.) Anchors for All Wall Types & Conditions

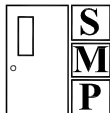

SECURITY METAL PRODUCTS CORP.

5700 Hannum Avenue Suite # 250
Culver City, CA 90230

ph. (310) 641-6690
fx. (310) 641-6601

JOB NAME:

JOB NO.:

PAGE: